

## Connection

- The track accessories are provided with earth connection points on both sides.
- When offering the accessory to the track, verify which tab needs to be removed. (See left hand diagram).
- To remove the tab, grasp firmly with a pair of pliers and lever back. The tab should snap cleanly off. (See right hand diagram).
- Locate the accessory in the track and push home.
- Locate the product in the track with the connections in the slot.
- Our recommendation would be to remove a section of material from the end of the track that is opposite to that of the live feed. This would ensure a perfect connection and trouble free operation. Always ensure that the locking screw is tightened.

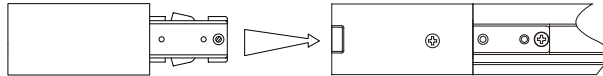
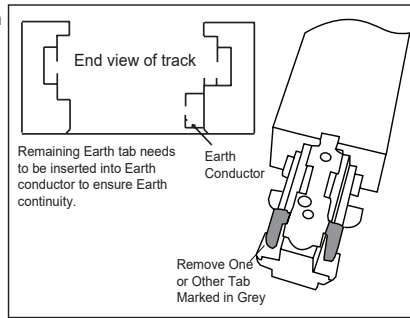

## Max total length of track/ load

Item	Model	Component for track system	Rating input	Max total load weight	Max total length of track
1	78654 / 78655 / 78656	1 meter 3 wire track	220-240VAC, 16A	Max. 15kg	50M
2	78657 / 78658 / 78659	2 meter 3 wire track	220-240VAC, 16A	Max. 20kg	
3	78660 / 78661 / 78662	3 meter 3 wire track	220-240VAC, 16A	Max. 30kg	

## Wiring

- Undo the screw and remove the cover from the live end. Push out the desired cable access point.
- Identify the correct cable from the supply and pull through.
- Connect the supply wires to the terminal block, opposite the corresponding wires from the fitting. The central connector can also be wired in this way.
- Refit the cover onto the live end taking care not to trap the cable.

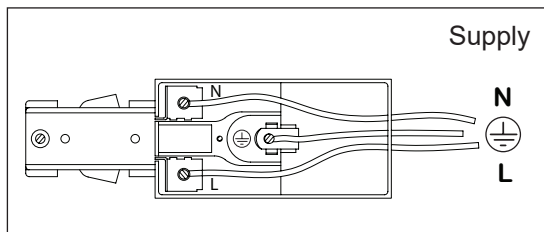

### Check that.....

- You have correctly identified the wires.
- The connections are tight.
- No loose strands have been left out of the connection block.

## Instruction leaflet

# Track 1m/2m/3m

78654, 78655, 78656, 78657, 78658, 78659, 78660, 78661, 78662



## Care and Safety

- We recommend cleaning with a soft dry cloth. Do not use solvents or abrasive cleaners as these could damage the finish.
- For your safety, always switch off the supply before cleaning.

Iss .4 07/03/2019



saxby  
lighting

Thank you for purchasing this light fitting. Please read the instructions carefully before use to ensure safe and satisfactory operation of this product. Please retain these instructions for future reference.

## Warning

Please read these instructions carefully before commencing any work.

This unit must be fitted by a competent and qualified electrician.

Install in accordance with IEE Wiring regulations and current Building Regulations.

Check the pack and make sure you have all of the parts listed.

To prevent electrocution switch off at mains supply before installing or maintaining this fitting.

Ensure other persons cannot restore the electrical supply without your knowledge.

This light fitting should be connected to a fused circuit.

If replacing an existing fitting, make a careful note of the connections.

Always switch off mains supply before fitting or servicing.



All pre-cut mains tracks, is supplied complete with ready inserted dead end insulation caps and live end.

It is recommended that luminaires are installed by a qualified electrician who should ensure that the installation complies with the current IEE wiring regulations BS7671:2008.

Any broken or damaged parts should be replaced as soon as possible.

Saxby will not accept responsibility for any claims arising from a sub-standard installation.

## Technical data

Supply Voltage:	240V~, 50 Hz	16 Amp max	Power load : Max. 3840W
	Conformity with all relevant EC Directive requirements.		
	Waste electrical products should not be disposed of with household waste. Please recycle where facilities exist. Check with your Local Authority or local store for recycling advice.		
	Class I product, must be connected to earth.		
<b>IP20</b>			

## Layout

This track system can be extended to a variety of different configurations using accessories such as left bends, right bends, T junctions, X junctions and flexible joints.

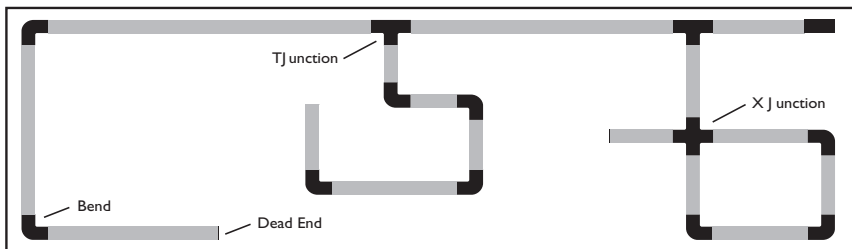

## Track accessory

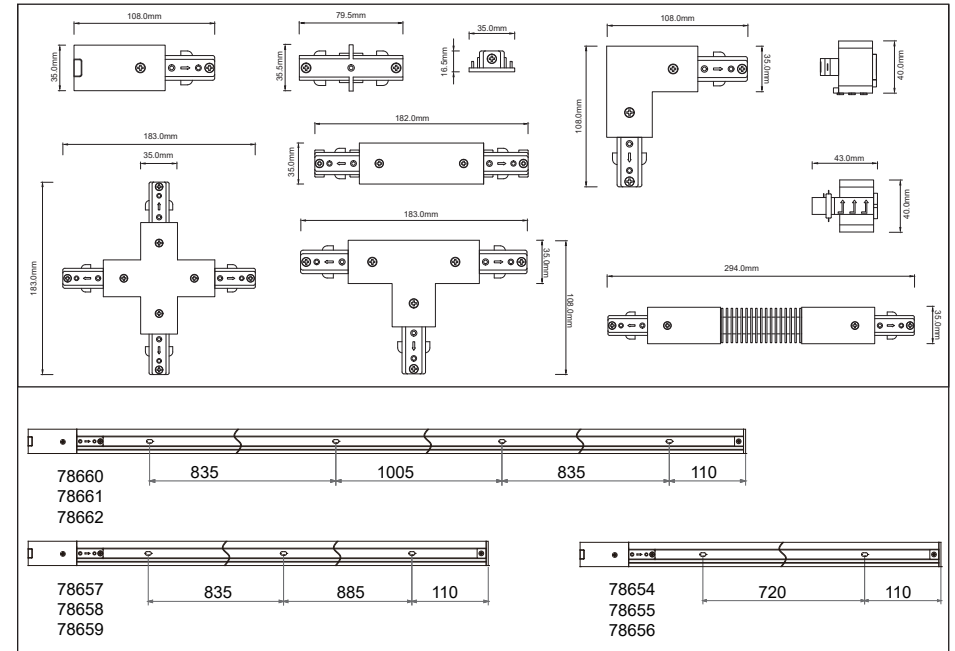

## Installation

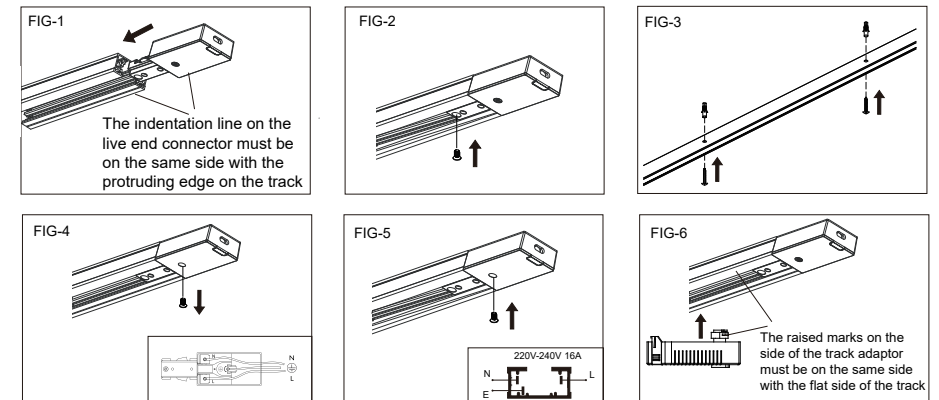

## Cutting track

When reducing the length of track i.e. cutting down. It is recommended that a piece of masking tape be wrapped around the intended cutting area, this will ensure the powder coated or plated finish does not lift and chip. It is recommended for a good electrical connection the installer should always mark out and cut track accurately using an engineers square prior to cutting. Ensure the copper conductors are pushed fully to one end of the track prior to cutting. the conductors should be towards the live end termination point